



MANUAL: Twister® and BubbleCup® Nozzles

INSTRUCTIONS FOR INSTALLATION, SAFE OPERATION AND MAINTENANCE

▲ WARNING

Read instruction manual before use. Operation of this nozzle without understanding the manual and receiving proper training can be dangerous and is a misuse of this equipment. Call 800-348-2686 with any questions.

▲ WARNING

This instruction manual is intended to familiarize firefighters and maintenance personnel with the operation, servicing and safety procedures associated with the Twister and BubbleCup Handline fire fighting nozzles.

▲ WARNING

This manual should be kept available to all operating and maintenance personnel.

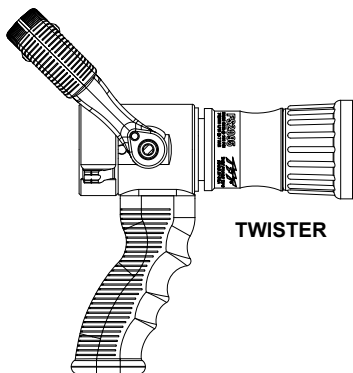

TWISTER

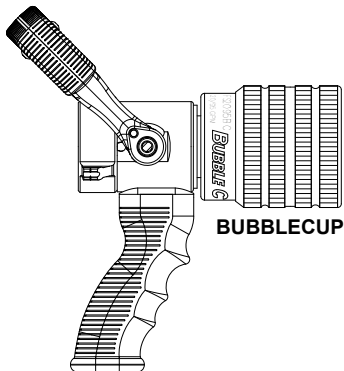

BUBBLECUP

▲ DANGER

PERSONAL RESPONSIBILITY CODE

The member companies of FEMSA that provide emergency response equipment and services want responders to know and understand the following:

1. Firefighting and Emergency Response are inherently dangerous activities requiring proper training in their hazards and the use of extreme caution at all times.
2. It is your responsibility to read and understand any user's instructions, including purpose and limitations, provided with any piece of equipment you may be called upon to use.
3. It is your responsibility to know that you have been properly trained in Firefighting and/or Emergency Response and in the use, precautions, and care of any equipment you may be called upon to use.
4. It is your responsibility to be in proper physical condition and to maintain the personal skill level required to operate any equipment you may be called upon to use.
5. It is your responsibility to know that your equipment is in operable condition and has been maintained in accordance with the manufacturer's instructions.
6. Failure to follow these guidelines may result in death, burns or other severe injury.



Fire and Emergency Manufacturers and Service Association
P.O. Box 147, Lynnfield, MA 01940 • www.FEMSA.org

TASK FORCE TIPS, INC.
MADE IN USA • www.tft.com





3701 Innovation Way, Valparaiso, IN 46383-9327 USA
800-348-2686 • 219-462-6161 • Fax 219-464-7155

Table Of Contents







1.0 MEANING OF SIGNAL WORDS	5.0 FLOW CHARACTERISTICS
1.1 SAFETY	5.1 REACH & TRAJECTORY
2.0 GENERAL INFORMATION	5.1.1 TWISTER & BUBBLECUP FLOWS
2.1 VARIOUS MODELS	5.1.2 METRIC TWISTER & BUBBLECUP FLOWS
2.1.1 COMMON MODELS AND TERMS	6.0 USE WITH SALT WATER
2.2 COLOR CODED VALVE HANDLE COVERS	7.0 FOAMJET MX WITH TWISTER NOZZLES
2.3 MECHANICAL SPECIFICATIONS	8.0 FIREGROUND USE OF TWISTER & BUBBLECUP NOZZLES
3.0 NOZZLE CONTROLS	9.0 FIELD INSPECTION
3.1 FLOW CONTROLS	10.0 INSPECTION CHECKLIST
3.1.1 TIP ONLY NOZZLES	11.0 ANSWERS TO YOUR QUESTIONS
3.1.2 BALL SHUTOFF	12.0 DRAWINGS AND PARTS LIST
3.2 PATTERN & FLUSH CONTROL	13.0 WARRANTY
3.2.1 PATTERN CONTROL	
4.0 BUBBLECUP NOZZLES	

1.0 MEANING OF SAFETY SIGNAL WORDS

A safety related message is identified by a safety alert symbol and a signal word to indicate the level of risk involved with a particular hazard. Per ANSI standard Z535.6-2006, the definitions of the four signal words are as follows:

	DANGER indicates a hazardous situation which, if not avoided, will result in death or serious injury.
	WARNING indicates a hazardous situation which, if not avoided, could result in death or serious injury.
	CAUTION indicates a potentially hazardous situation which, if not avoided, may result in minor or moderate injury.
	NOTICE is used to address practices not related to personal injury.

1.1 SAFETY

	An inadequate supply of nozzle pressure and/or flow will cause an ineffective stream and can result in injury, death or loss of property. See flow charts in Section 5.0 or call 800-348-2686 for assistance.
	Failure to restrain nozzle reaction can cause firefighter injury from loss of footing and/or stream protection. Nozzle reaction will vary as supply conditions change: such as opening or closing other nozzles, hose line kinks, changes in pump settings, etc. Changes in spray pattern or flushing will also affect nozzle reaction. The nozzle operator must always be positioned to restrain the nozzle reaction in the event of those changes.
	Injury from whipping can occur. If nozzle gets out of control or away from operator, retreat from nozzle immediately. Do not attempt to regain control of nozzle while flowing water.
	Nozzle reaction will vary as supply conditions change: such as opening or closing other nozzles, hose line kinks, changes in pump settings, etc. Changes in spray pattern or flushing will also affect nozzle reaction. The nozzle operator must always be prepared in the event of those changes. Failure to restrain nozzle reaction can cause firefighter injury from loss of footing and/or stream protection.
	If nozzle gets out of control or away from operator, retreat from nozzle immediately. Do not attempt to regain control of nozzle while flowing water. Injury from whipping can occur.
	Large amounts or pieces of debris may be unflushable and can reduce the flow of the nozzle resulting in an ineffective flow. In the event of a blockage, it may be necessary to retreat to a safe area, uncouple nozzle and remove debris.

▲ WARNING

Water is a conductor of electricity. Application of water solutions on high voltage equipment can cause injury or death by electrocution. The amount of current that may be carried back to the nozzle will depend on the following factors:

- Voltage of the line or equipment¹
- Distance from the nozzle to the line or equipment
- Size of the stream
- Whether the stream is solid or broken
- Purity of the water²

¹ Electrostatic Hazards of Foam Blanketing Operations by Peter Howels. Industrial Fire Safety July/August 1993

² The Fire Fighter and Electrical Equipment, The University of Michigan Extension Service, Fourth Printing 1983. Page 47.

▲ CAUTION

Fire streams are capable of injury and damage. Do not direct water stream to cause injury or damage to persons or property.

▲ CAUTION

Do not couple aluminum to brass. Dissimilar metals coupled together can cause galvanic corrosion that can result in inability to unscrew threads or complete loss of thread engagement.

▲ CAUTION

The nozzle may become damaged if allowed to freeze while containing water. Always drain after use to avoid damage and possible loss of use.

▲ CAUTION

Nozzle must be mated to a hose line with matched threads. Mismatched or damaged threads may cause nozzle to leak or uncouple from hose under pressure and could cause injury.

2.0 GENERAL INFORMATION

The Task Force Tips Twister and Bubblecup nozzles are hand-held nozzles with clean far reaching straight stream. They are adjustable from straight stream to a wide fog pattern. Their rugged construction is compatible with the use of fresh water as well as fire fighting foam solutions. The nozzles are constructed of hard anodizes aluminum, stainless steel, rubber and engineering grade polymers. A summary of each nozzle's characteristics is shown in the tables below.

▲ WARNING

This equipment is intended for use by trained personnel for firefighting. Their use for other purposes may involve hazards not addressed by this manual. Seek appropriate guidance and training to reduce risk of injury.

2.1 VARIOUS MODELS

SERIES	MODEL	STANDARD COUPLING SIZE	GALLONAGE SETTINGS (GPM AT 100 PSI)
C	TWISTER	3/4 GHT	10, 24
D	TWISTER or BUBBLECUP	1 NH	10, 24
D	TWISTER or BUBBLECUP	1 NH	10, 40
F	TWISTER or BUBBLECUP	1-1/2 NH	20, 60
F	TWISTER	1-1/2 NH	20, 95
F	BUBBLECUP	1-1/2 NH	95 Single Gallonage Only

The C series Twister is available in a tip-only nozzle configuration. The D and F Series Twisters and Bubble Cups are available in tip-only, ball-valve, or ball-valve with pistol grip configurations.

NH (National Hose Threads per NFPA #1963) threads are standard on all nozzles. Other threads such as NPSH (National Pipe Straight Hose threads per ANSI/ASME #B1.20.7) can be specified at time of order.

2.1.1 COMMON MODELS AND TERMS

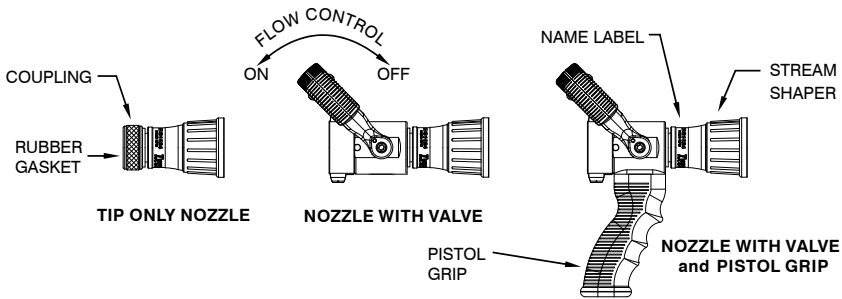

FIGURE 1 COMMON MODELS AND TERMS

2.2 COLOR CODED VALVE HANDLE AND PISTOL GRIP

The TFT Twister and BubbleCup with lever type valve handles are supplied with black valve handle covers and pistol grips. The handle covers and pistol grips are available from TFT in various colors for those departments wishing to color code the nozzle to the discharge controls. A colored handle cover set will be sent upon receipt of the warranty card by TFT. Your department's name can also be engraved on the covers (see warranty card for more information).

Handle covers are replaceable by removing the four screws that hold the handle covers in place. Use a 3/32" allen wrench when replacing screws. Pistol grip is replaceable by following TFT instruction sheet LTT-108.

For standardization NFPA 1901 (A-4-9.3) recommends the following color code scheme:

Preconnect #1 or Bumper Jump Line	Orange	Other Colors Available:
Preconnect or discharge #2	Red	• Gray
Preconnect or discharge #3	Yellow	• Pink
Preconnect or discharge #4	White	• Purple
Preconnect or discharge #5	Blue	• Tan
Preconnect or discharge #6	Black	
Preconnect or discharge #7	Green	
Foam Lines	Red w/ White border (Red/White)	

2.3 MECHANICAL SPECIFICATIONS

Maximum nozzle inlet pressure with valve shutoff*	Twister 300 psi	20 bar
	BubbleCup 300 psi	20 bar
Operating temperature range of fluid	33 to 120° F	1 to 50° C
Storage temperature range	-40 to 150° F	-40 to 65° C
Materials used	Aluminum 6000 series hard anodized ML8625 class 3 type 2, stainless steel 300 series, nylon 6-6, nitrile rubber	
*Consult Factory for higher pressure applications		

3.0 NOZZLE CONTROLS

3.1 FLOW CONTROL

3.1.1 LEVER TYPE FLOW CONTROL

On models that use a lever type valve handle, the nozzle is shut off when the handle is fully forward. The ball valve allows the nozzle operator to regulate the flow of the nozzle depending on the need or what can be safely and effectively handled. TFT recommends the use of a pistol grip for easier handling. For additional stress reduction, a hose rope or strap may also be used. This permits more effective use and ease of advancement, while minimizing strain and fatigue.

3.1.2 TIP ONLY NOZZLES

Tip only nozzles have NO shut off valve contained within the nozzle and MUST be used with a separate ball valve attached to the nozzle.

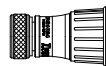

3.1.2 BALL SHUTOFF

Models with a ball valve are shut off when the valve handle is fully forward. Pulling back on the handle opens the valve. Open valve slowly to avoid sudden changes in nozzle reaction. Note: In partially-open positions a ball valve will cause turbulence and adversely affect stream quality. Close valve slowly to prevent water hammer.

3.2 PATTERN AND FLUSH CONTROL

3.2.1 PATTERN CONTROL

TFT's Twister and BubbleCup Nozzles have full pattern control from straight stream to wide fog. Turning the STREAM SHAPER clockwise (as seen from the operating position behind the nozzle) moves the SHAPER to the straight stream position. Turning the SHAPER counterclockwise will result in an increasingly wider pattern.

Since the stream trim point varies with the flow, the stream should be "trimmed" after changing the flow to obtain the straightest and farthest reaching stream. To properly trim a stream, first open the pattern to a narrow fog. Then close the stream to parallel to give maximum reach. NOTE: Turning the shaper further forward will cause stream crossover and reduce the effective reach of the nozzle.

The nozzle reaction is greatest when the shaper is in the straight stream position. The nozzle operator must be prepared for a change in reaction as the pattern is changed.

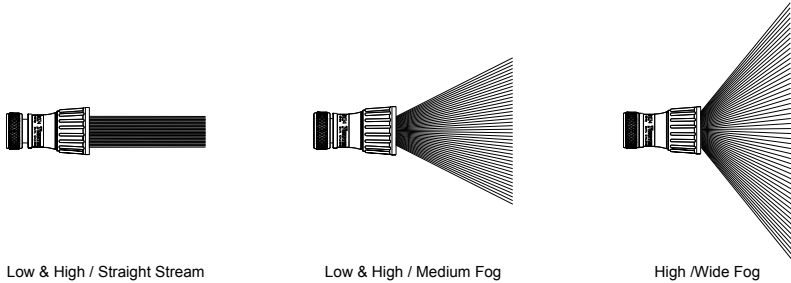

FIGURE 2 CHANGING PATTERN AND FLOW SETTINGS

WARNING Large amounts of debris can reduce the flow of the nozzle resulting in an ineffective flow. In the event of a blockage it may be necessary to retreat to a safe area, uncouple nozzle and remove debris.

4.0 BUBBLECUP NOZZLES

The Bubble Cup nozzle is capable of producing aspirated foam as well as a conventional straight stream and wide protective fog pattern. The Bubble Cup functions just like the Twister nozzle (see section 3.0) when the gray sleeve is in the retracted position as in figure 3A.

To use the aspirating feature of the Bubble Cup, the nozzle operator need only slide the gray sleeve portion of the nozzle forward. When the sleeve is in the fully-extended position, a white line on the shaper will be visible at the base of the gray sleeve as in figure 3B. Rotation of the shaper when the sleeve is extended will provide the nozzle operator control of reach and aspiration. If an immediate wide protective fog pattern is needed, the sleeve can be retracted instantly to its regular position.

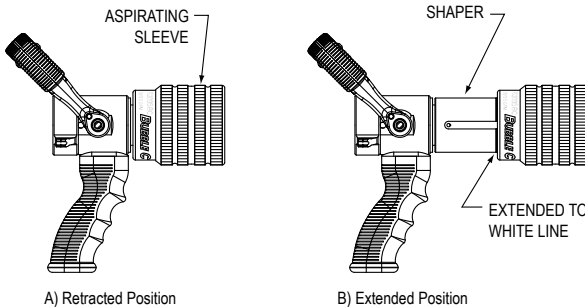
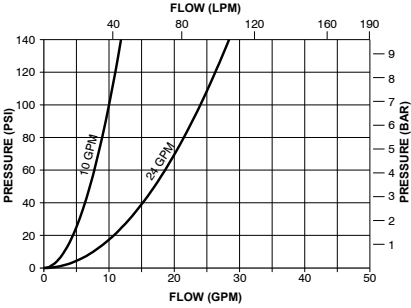

FIGURE 3 BUBBLE CUP OPERATING POSITIONS

5.0 FLOW CHARACTERISTICS

At each gallonage setting the nozzle is set to a predetermined fixed orifice. Relationship of flow and nozzle pressure at each setting is shown in figures 4A and 4B.



10, 24 GPM TWISTER OR BUBBLE CUP

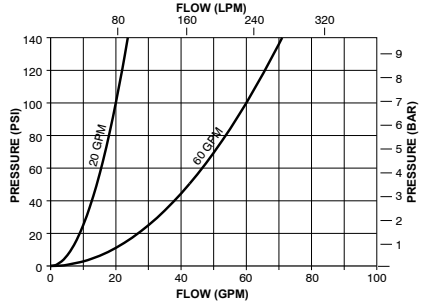

20, 60 GPM TWISTER OR BUBBLE CUP

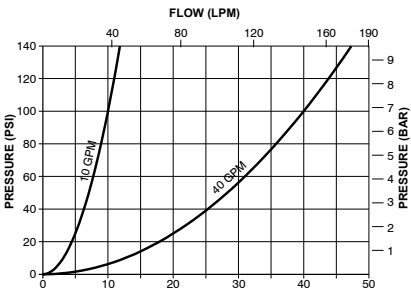

10, 40 GPM TWISTER OR BUBBLE CUP

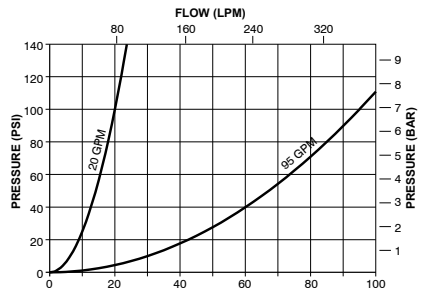

20, 95 GPM TWISTER OR
95 GPM BUBBLE CUP

Figure 4A

Figure 4B

The charts on the pages 7-8 of this document give specific examples of pump pressure and flow for various hoses and lengths. Losses may vary due to differences in hose construction resulting in flows different than shown. For situations or lengths of hose not listed on the chart, approximate flows can be calculated using conventional hydraulics.

5.1 REACH AND TRAJECTORY

Specific data is published in technical documents LTT-140 and LTT-145 entitled Reach & Trajectory Data of Hand Held Nozzles. The following charts give specific examples of maximum flow rates for particular situations. Friction losses may vary due to differences in hose construction resulting in flows different than those shown. For situations or lengths of hose not listed on the chart, approximate flows can be calculated using conventional hydraulics.

5.1.1 TWISTER & BUBBLECUP FLOWS

3/4" HOSE

FLOW SETTING	100 FT			200 FT			300 FT		
	10	24	40	10	24	40	10	24	40
50	7	13	17	6	11	13	6	10	11
100	9	19	24	9	16	19	9	14	16
150	12	23	29	11	20	23	11	17	20
200	13	27	34	13	23	27	12	20	23
250	15	30	38	14	25	30	14	22	25
300	16	33	42	16	28	33	15	24	28
350	18	35	45	17	30	35	16	26	30
400	19	38	48	18	32	38	17	28	32
450	20	40	51	19	34	40	18	30	34
500	21	42	54	20	36	42	19	32	36
550	22	44	56	21	37	44	20	33	37
600	23	46	59	22	39	46	21	35	39

1" HOSE

FLOW SETTING	100 FT			200 FT			300 FT		
	10	24	40	10	24	40	10	24	40
50	7	16	25	7	16	23	7	15	22
100	10	23	36	10	22	33	10	21	31
150	12	28	44	12	27	40	12	26	37
200	14	33	51	14	31	47	14	30	43
250	16	36	57	16	35	52	15	34	48
300	17	40	62	17	38	57	17	37	53
350	19	43	67	18	41	62	18	40	57
400	20	46	72	20	44	66	20	43	61
450	21	49	76	21	47	70	21	45	65
500	22	51	80	22	50	74	22	48	68
550	23	54	84	23	52	77	23	50	72
600	24	56	88	24	54	81	24	52	75

1-1/2" HOSE

FLOW SETTING	150 FT			200 FT			250 FT		
	20	60	95	20	60	95	20	60	95
50	14	40	58	14	39	56	14	38	54
75	17	49	71	17	48	69	17	47	66
100	20	56	82	20	55	79	20	54	76
125	22	63	92	22	62	89	22	61	85
150	24	69	101	24	68	97	24	67	94
175	26	75	109	26	73	105	26	72	101
200	28	80	117	28	78	112	28	77	108
225	30	85	124	30	83	119	30	82	115
250	31	89	130	31	88	125	31	86	121

1-3/4" HOSE

FLOW SETTING	150 FT			200 FT			250 FT		
	20	60	95	20	60	95	20	60	95
50	14	41	61	14	40	59	14	40	58
75	17	50	75	17	49	73	17	49	71
100	20	58	86	20	57	84	20	56	82
125	22	64	96	22	64	94	22	63	91
150	24	71	106	24	70	103	24	69	100
175	26	76	114	26	75	111	26	74	108
200	28	82	122	28	80	119	28	79	116
225	30	86	129	30	85	126	30	84	123
250	31	91	136	31	90	133	31	89	129

- 1) Number in each box is flow in gallons per minute.
- 2) Actual flows may vary with brand and condition of hose.
- 3) Flows are approximate and do not account for losses in preconnect piping or changes in elevation.

5.1.2 METRIC TWISTER & BUBBLECUP FLOWS

FLOW SETTING	30 Meters			60 Meters			90 Meters		
	10	24	40	10	24	40	10	24	40
3.5	25	50	65	25	40	50	25	40	40
7	35	70	90	35	60	70	35	55	60
10	45	85	110	40	75	85	40	65	75
14	50	100	130	50	85	100	45	75	85
17	55	115	145	55	95	115	55	85	95
21	60	125	160	60	105	125	55	90	105
24	70	130	170	65	115	130	60	100	115
28	70	145	180	70	120	145	65	105	120
31	75	150	195	70	130	150	70	115	130
34	80	160	205	75	135	160	70	120	135
38	85	165	210	80	140	165	75	125	140
41	85	175	225	85	150	175	80	130	150

FLOW SETTING	30 Meters			60 Meters			90 Meters		
	10	24	40	10	24	40	10	24	40
3.5	25	60	95	25	60	85	25	55	85
7	40	85	135	40	85	125	40	80	115
10	45	105	165	45	100	150	45	100	140
14	55	125	195	55	115	180	55	115	165
17	60	135	215	60	130	195	55	130	180
21	65	150	235	65	145	215	65	140	200
24	70	165	255	70	155	235	70	150	215
28	75	175	275	75	165	250	75	165	230
31	80	185	290	80	180	265	80	170	245
34	85	195	305	85	190	280	85	180	255
38	85	205	320	85	195	290	85	190	275
41	90	210	335	90	205	305	90	195	285

FLOW SETTING	45 Meters			60 Meters			75 Meters		
	20	60	95	20	60	95	20	60	95
3.5	55	150	220	55	150	210	55	145	205
5.2	65	185	270	65	180	260	65	180	250
7	75	210	310	75	210	300	75	205	290
8.6	85	240	350	85	235	335	85	230	320
10	90	260	380	90	255	365	90	255	355
12	100	285	415	100	275	395	100	275	380
14	105	305	445	105	295	425	105	290	410
15.5	115	320	470	115	315	450	115	310	435
17	115	335	490	115	335	475	115	325	460

FLOW SETTING	45 Meters			60 Meters			75 Meters		
	20	60	95	20	60	95	20	60	95
3.5	55	155	230	55	150	225	55	150	220
5.2	65	190	285	65	185	275	65	185	270
7	75	220	325	75	215	320	75	210	310
8.6	85	240	365	85	240	355	85	240	345
10	90	270	400	90	265	390	90	260	380
12	100	290	430	100	285	420	100	280	410
14	105	310	460	105	305	450	105	300	440
15.5	115	325	490	115	320	475	115	320	465
17	115	345	515	115	340	505	115	335	490

- 1) Number in each box is flow in liters per minute.
- 2) Actual flows may vary with brand and condition of hose.
- 3) Flows are approximate and do not account for losses in preconnect piping or changes in elevation.
- 4) 1BAR = 100 KPA

6.0 USE WITH SALT WATER

Use with salt water is permissible provided nozzle is thoroughly cleaned with fresh water after each use. The service life of the nozzle may be shortened due to the effects of corrosion and is not covered under warranty.

7.0 FOAMJET MX WITH TWISTER NOZZLE

To increase the expansion ratio Task Force Tips "Foamjet MX" (model FJ-MX-D) may be used with the Twister nozzle. This multi-expansion foam tube attaches and detaches quickly from the nozzle. Note: As expansion ratio is increased, the reach of the stream will be decreased due to the greater amount of bubbles in the stream and their inability to penetrate the air. Generally, the reach with foam is approximately 10 % less than with water only. Actual results will vary based on brand of foam, hardness of water, temperature, etc.

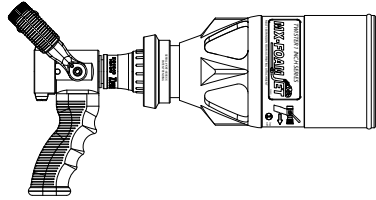

FIG 4 - FJ-MX-D Shown on Twister Nozzle

WARNING

For Class B fires, lack of foam or interruption in the foam stream can cause a break in the foam blanket and greatly increase the risk of injury or death. Assure that:

- Application rate is sufficient (see NFPA 11 or foam manufacturer's recommendations).
- Enough concentrate is on hand to complete task (see NFPA for minimum duration time requirements).
- Foam logistics have been carefully planned. Allow for such things as:
- Storage of foam in a location not exposed to the hazard it protects.
- Personnel, equipment and technique to deliver foam at a rapid enough rate.
- Removal of empty foam containers.
- Keeping clear path to deliver foam as hoses, other equipment and vehicles are deployed.

WARNING

Improper use of foam can result in injury or damage to the environment. Follow foam manufacturer's instructions and fire service training to avoid:

- Using wrong type of foam on a fire, i.e. Class A foam on a Class B fire.
- Plunging foam into pools of burning liquid fuels.
- Causing environmental damage.
- Directing stream at personnel.

WARNING

There is a wide variety of foam concentrates. Each user is responsible for verifying that any foam concentrate chosen to be used with this unit has been tested to assure that the foam obtained is suitable for the purpose intended.

8.0 FIREGROUND USE OF TWISTER AND BUBBLE CUP NOZZLES

IT IS THE RESPONSIBILITY OF THE INDIVIDUAL FIRE DEPARTMENT OR AGENCY TO DETERMINE PHYSICAL CAPABILITIES AND SUITABILITY FOR AN INDIVIDUAL'S USE OF THIS EQUIPMENT.

Many factors contribute to the extinguishment of a fire. Among the most important is delivering water at a flow rate sufficient to absorb heat faster than is being generated. The flow rate depends largely on the pump discharge pressure and hose friction loss. The pump discharge pressure may be found by use of the chart on the last page. It can also be calculated using a hydraulic equation such as:

$$PDP = NP + FL + DL + EL$$

PDP = Pump discharge pressure in PSI

NP = Nozzle pressure in PSI

FL = Hose friction loss in PSI

DL = Device loss in PSI

EL = Elevation loss in PSI

For additional information on calculating specific hose layouts, consult an appropriate fire service training manual, A Guide to Automatic Nozzles, or call TFT's "Hydraulics Hotline" at 800-348-2686.

9.0 FIELD INSPECTION

Twister and Bubble Cup are designed and manufactured to be damage resistant and require minimal maintenance. However, as the primary firefighting tool upon which your life depends, it should be treated accordingly.



Before each use nozzle must be inspected for proper operation and function according to inspection checklist in section 10.0 of this document. Any nozzle that fails inspection is dangerous to use and must be repaired before using.

Performance tests shall be conducted on the Twister and Bubble Cup nozzle after a repair, or anytime a problem is reported to verify operation in accordance with Task Force Tips test procedures. Consult factory for the procedure that corresponds to the model and serial number of the nozzle. Any equipment which fails the related test criteria should be removed from service immediately. Troubleshooting guides are available with each test procedure or equipment can be returned to the factory for service and testing. Factory service is available with repair time seldom exceeding one day in our facility. Factory-serviced nozzles are repaired by experienced technicians to original specifications, fully wet tested, and promptly returned. Repair charges for non-warranty items are minimal. Any returns should include a note as to the nature of the problem and whom to reach in case of questions.

Repair parts and service procedures are available for those wishing to perform their own repairs. Task Force Tips assumes no liability for damage to equipment or injury to personnel that is a result of user service.

SPECIAL CONFIGURATIONS: If nozzles are made according to the special marking or performance requirements of the fire department then the operating characteristics may differ from the published data in this manual. Repair parts specific to each serial number may differ from those shown in the service procedure. The required parts for each serial number are available on-line by entering www.tft.123456 with numbers corresponding to the serial number engraved on the product.

Consult TFT for laser engraved handle covers, special labeling, logos, and special laser engraving on the nozzle.



Any alterations to the nozzle and its markings could diminish safety and constitutes a misuse of this product.

All Task Force Tip nozzles are factory lubricated with high quality silicone grease. This lubricant has excellent washout resistance and long term performance. If your department has unusually hard or sandy water, the moving parts may be affected. Foam agents and water additives contain soaps and chemicals that may break down the factory lubrication.

The moving parts of the nozzle should be checked on a regular basis for smooth and free operation, and signs of damage. **IF THE NOZZLE IS OPERATING CORRECTLY, THEN NO ADDITIONAL LUBRICATION IS NEEDED.** Any nozzle that is not operating correctly should be immediately removed from service and the problem corrected.

10.0 INSPECTION CHECKLIST

Nozzle must be inspected for proper operation and function according to this checklist before each use.

Check that:

- 1) There is no obvious damage such as missing, broken or loose parts, damaged labels, etc.
- 2) Coupling is tight and leak free
- 3) Valve handle moves freely through full range and shuts off flow
- 4) Nozzle flow is adequate as indicated by pump pressure and nozzle reaction
- 5) Shaper turns freely and adjusts pattern through full range and shuts off flow
- 6) On Bubble Cups, aspirating sleeve slides freely and is secure at both ends

If a nozzle needs service, refer to the following documents:

Service Procedure: 1.0" Twister and 1.0" BubbleCup LKD-010

Service Procedure: 1.5" Twister and 1.5 " BubbleCup LKF-010



Any twister or bubble cup nozzle failing any part of the inspection checklist is unsafe and must have the problem corrected before use. Operating a nozzle that fails any of the above inspections is a misuse of this equipment.

11.0 ANSWERS TO YOUR QUESTIONS

We appreciate the opportunity of serving you and making your job easier. If you have any problems or questions, our toll-free "Hydraulics Hotline", 800-348-2686, is normally available to you 24 hours a day, 7 days a week.

12.0 DRAWINGS AND PARTS LIST

D Series Twister and BubbleCup **Pages 12-13**

F Series Twister and BubbleCup **Pages 14-15**

D Series Twister and BubbleCup

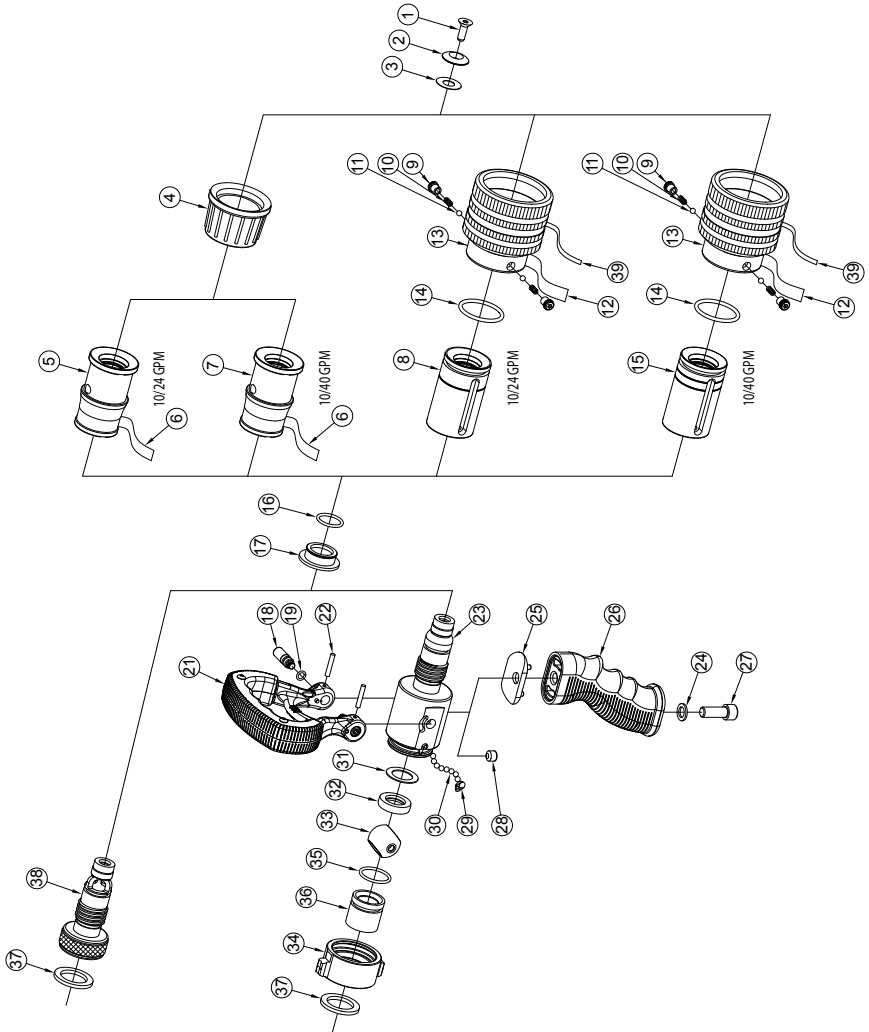

ITEM	DESCRIPTION	QTY	PART #
1	1/4-20 X 3/4 FLATHEAD	1	VT25E20FH750
2	BAFFLE	1	D230
3	SEAT	1	D250
4	D TWISTER BUMPER	1	D275
5	HEAD 10/24	1	D225
6*	NAME LABEL	1	DL75 DL70
7	HEAD 10/40	1	D425
8	FOAM HEAD 10/24	1	D223
9	DETENT SCREW	2	D290
10	SPRING HELICAL COMPRESSION	2	VM4195
11	3/16" TORLON BALL	2	V2120-TORLON
12*	NAME LABEL	1	DL74 DL73
13	CUP W/TEETH	1	D285
14	O-RING-221	1	VO-221
15	FOAM HEAD 10/40	1	D423
16	O-RING-117	1	VO-117
17	Z STRIP	1	D405
18	75 TRUNNION	2	D07540
19	O-RING-010	2	VO-010
21	DQ HANDLE SUBASSEMBLY	1	DQ860
	75 SHUTOFF HANDLE	1	D07560
	BLACK HANDLE COVER	2	HM625-BLK
	8-32 X 3/8 BUTTON HEAD SCREW	4	VT08-32BH375
	75 STOP PIN	2	D07550
22	SPIROL PIN	2	V1900
23	75 TWISTER VALVE BODY	1	D07525
24	WASHER	1	VM4901
25	GRIP SPACER D075	1	HM693-D
26	PISTOL GRIP - BLACK	1	HM692-BLK
27	3/8-16 X 1 SOCKET HEAD SCREW	1	VT37-16SH1.0
28	3/8-16 X 5/16 SET SCREW	1	VT37-16SS312
29	PORT PLUG	1	B770
30	3/16" SS BALL	26	V2120
31	BELLEVILLE WASHER	1	D07590
32	75 FRONT SEAT	1	D07570
33	75 BALL	1	D07530
34**	COUPLING 1.0"	1	D07597
35	O-RING-120	1	VO-120
36	75 REAR SEAT	1	D07580
37	GASKET - 1.0"	1	V3040
38**	BASE 1.0"	1	D210
39	BUBBLE CUP STRIPE LABEL	1	DL285

* - CONSULT FACTORY FOR SPECIFIC PART NUMBERS CORRESPONDING TO THE FLOW SETTINGS ON NOZZLE

** - STATE DESIRED THREAD WHEN ORDERING

F Series Twister and BubbleCup

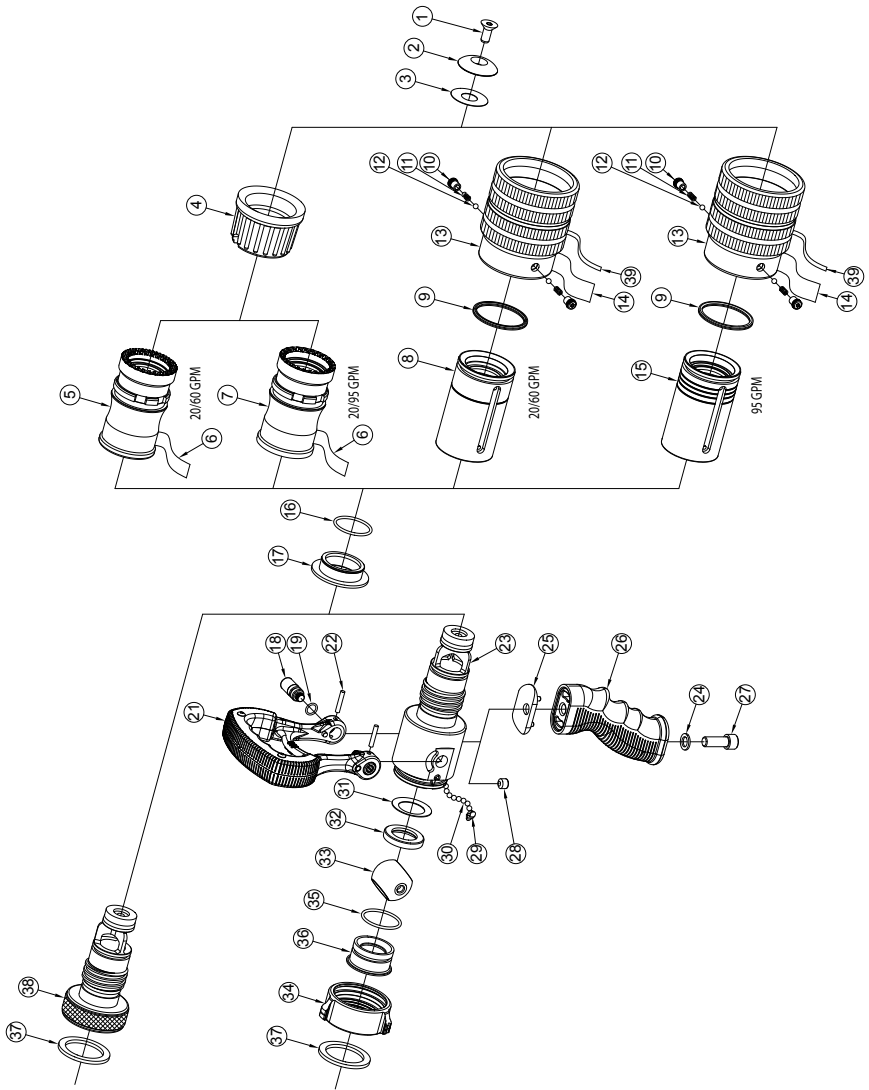

ITEM	DESCRIPTION	QTY	PART #
1	5/16-18 X 3/4 FLAT HEAD	1	VT31E18FH750
2	BAFFLE	1	F630
3	SEAT	1	F650
4	DQ BUMPER	1	DQ275
5	HEAD 20/60	1	F625
6	LABEL	1	FL70 FL75
7	HEAD 20/95	1	F925
8	FOAM HEAD 20/60	1	F623
9	QUAD RING-225	1	VOQ-4225
10	DETENT SCREW	2	D290
11	SPRING HELICAL COMPRESSION	2	VM4195
12	3/16" TORLON BALL	2	V2120-TORLON
13	CUP W/TEETH	1	F685
14	LABEL	1	FL80 FL82
15	FOAM HEAD 95	1	F923
16	O-RING-125	1	VO-125
17	Z-STRIP	1	F605
18	100 TRUNNION	2	F10040
19	O-RING-012	2	VO-012
21	FQ HANDLE SUBASSEMBLY	1	FQ860
	SHUT OFF HANDLE	1	F10060
	BLACK HANDLE COVER	2	HM625-BLK
	8-32 X 3/8 BUTTON HEAD SCREW	4	VT08-32BH375
	100 STOP PIN	2	F10050
22	SPIROL PIN	2	V1900
23	100 TWISTER VALVE BODY	1	F10025
24	FLAT WASHER	1	VM4901
25	GRIP SPACER F100	1	HM693-F
26	PISTOL GRIP - BLACK	1	HM692-BLK
27	3/8-16 X 1 SOCKET HEAD SCREW	1	VT37-16SH1.0
28	3/8-16 X 5/16 SET SCREW	1	VT37-16SS312
29	PORT PLUG	1	B770
30	3/16" SS BALL	34	V2120
31	BELLEVILLE WASHER	1	F10090
32	100 FRONT SEAT	1	F10070
33	100 BALL	1	F10030
34**	COUPLING 1.5"	1	F10097
35	O-RING-126	1	VO-126
36	100 REAR SEAT	1	F10080
37	GASKET - 1.5"	1	V3130
38**	BASE 1.5"	1	F610
39	BUBBLE CUP STRIPE LABEL	1	FL685

* - CONSULT FACTORY FOR SPECIFIC PART NUMBERS
CORRESPONDING TO THE FLOW SETTINGS ON NOZZLE

** - STATE DESIRED THREAD WHEN ORDERING

13.0 WARRANTY

Task Force Tips, Inc., 3701 Innovation Way, Valparaiso, Indiana 46383-9327 USA ("TFT") warrants to the original purchaser of its Twister and BubbleCup series nozzles ("equipment"), and to anyone to whom it is transferred, that the equipment shall be free from defects in material and workmanship during the five (5) year period from the date of purchase.

TFT's obligation under this warranty is specifically limited to replacing or repairing the equipment (or its parts) which are shown by TFT's examination to be in a defective condition attributable to TFT. To qualify for this limited warranty, the claimant must return the equipment to TFT, at 3701 Innovation Way, Valparaiso, Indiana 46383-9327 USA, within a reasonable time after discovery of the defect. TFT will examine the equipment. If TFT determines that there is a defect attributable to it, TFT will correct the problem within a reasonable time. If the equipment is covered by this limited warranty, TFT will assume the expenses of repair.

If any defect attributable to TFT under this limited warranty cannot be reasonably cured by repair or replacement, TFT may elect to refund the purchase price of the equipment, less reasonable depreciation, in complete discharge of its obligations under this limited warranty. If TFT makes this election, claimant shall return the equipment to TFT free and clear of any liens and encumbrances.

This is a limited warranty. The original purchaser of the equipment, any person to whom it is transferred, and any person who is an intended or unintended beneficiary of the equipment, shall not be entitled to recover from TFT any consequential or incidental damages for injury to person and/or property resulting from any defective equipment manufactured or assembled by TFT. It is agreed and understood that the price stated for the equipment is in part consideration for limiting TFT's liability. Some states do not allow the exclusion or limitation of incidental or consequential damages, so the above may not apply to you.

TFT shall have no obligation under this limited warranty if the equipment is, or has been, misused or neglected (including failure to provide reasonable maintenance) or if there have been accidents to the equipment or if it has been repaired or altered by someone else.

THIS IS A LIMITED EXPRESS WARRANTY ONLY. TFT EXPRESSLY DISCLAIMS WITH RESPECT TO THE EQUIPMENT ALL IMPLIED WARRANTIES OF MERCHANTABILITY AND ALL IMPLIED WARRANTIES OF FITNESS FOR A PARTICULAR PURPOSE. THERE IS NO WARRANTY OF ANY NATURE MADE BY TFT BEYOND THAT STATED IN THIS DOCUMENT.

This limited warranty gives you specific legal rights, and you may also have other rights which vary from state to state.