



# Colored Pistol Grips

For IMPULSE Trigger Valve System Nozzles

Now you have an easy ability of matching your nozzles with NFPA standards for discharge line coding.

Pre-connect #1	Orange	TN691ORG-KIT
Pre-connect #2	Red	TN691RED-KIT
Pre-connect #3	Yellow	TN691YEL-KIT
Pre-connect #4	White	TN691WHT-KIT
Discharge #3	Blue	TN691BLU-KIT
Discharge #4	Black	TN691BLK-KIT
Discharge #5	Green	TN691GRN-KIT
	Gray	TN691GRY-KIT
	Pink	TN691PNK-KIT
	Purple	TN691PPL-KIT
	Tan	TN691TAN-KIT

We are offering 1 (one) FREE colored pistol grip with each nozzle purchased that has a factory installed pistol grip.

Please check the color you would like to receive, completely fill out the information below and return the form to us at:

**Task Force Tips, Inc.,  
Free Pistol Grip,  
3701 Innovation Way  
Valparaiso, IN 46383-9327**

**Or fax it to: 219-464-7155**

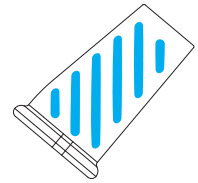
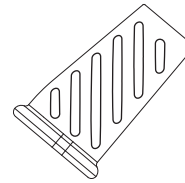
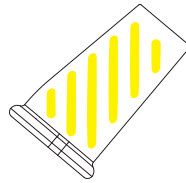
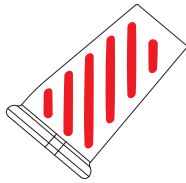
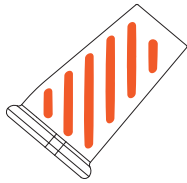

--	--	--	--	--

Orange

Red

Yellow

White

Blue

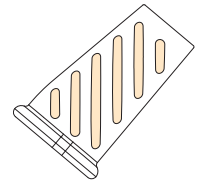
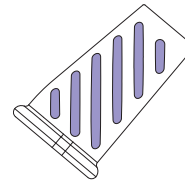
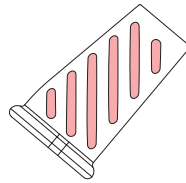
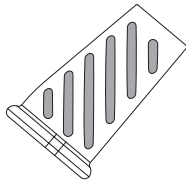
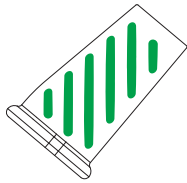

--	--	--	--	--

Green

Gray

Pink

Purple

Tan

F.D. \_\_\_\_\_

NAME \_\_\_\_\_

Address \_\_\_\_\_

RANK/TITLE \_\_\_\_\_

City/State \_\_\_\_\_

PHONE \_\_\_\_\_

Email \_\_\_\_\_

ZIP+ 4 \_\_\_\_\_

Web Site \_\_\_\_\_

FAX \_\_\_\_\_

**TASK FORCE TIPS, INC.**  
MADE IN USA • [www.tft.com](http://www.tft.com)

**3701 Innovation Way, Valparaiso, IN 46383-9327 USA**  
**800-348-2686 • 219-462-6161 • Fax 219-464-7155**

# Colored Pistol Grips

For IMPULSE Trigger Valve System Nozzles

## IMPULSE TRIGGER VALVE SYSTEM NOZZLE COLORED PISTOL GRIPS

The TFT Impulse Trigger Valve System nozzles are supplied with black pistol grip covers. The pistol grip covers are available from TFT in various colors for those departments wishing to color code the nozzle to the discharge controls. Follow the steps below to change the pistol grip cover.

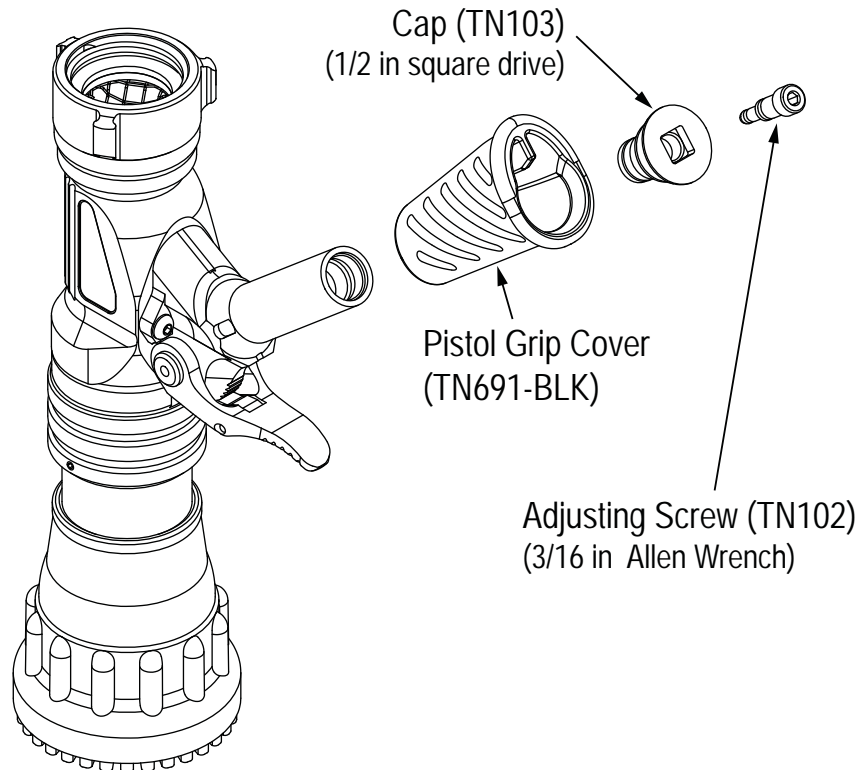

- 1) **Orient nozzle vertically.** This keeps the dampening fluid in the pistol grip from spilling out.
- 2) Remove the Cap. (1/2 in square drive) The Adjusting Screw (3/16 in Allen Wrench) may need to be turned in or removed to be able to engage the square pocket in the cap. Note the position of the Adjusting Screw before moving it.
- 3) Slide off the Pistol Grip Cover and install a new one. Be sure the Pistol Grip Cover's internal rib is toward the back of the nozzle.
- 4) Reinstall the Cap until it bottoms out on its shoulder.
- 5) Reinstall or reposition the Adjusting Screw if it has been moved from its original location.
- 6) Flow nozzle to check performance of slow closer. Adjust as needed.